

EXCLAMATION

53' UHD/3G/HD Double Expando

Production

Grass Valley K-Frame Switcher Frame
 Grass Valley Kayenne 4-Stripe 35-Button Control Panel with Aux
 4.5 M/Es available, 64 input, 48 output, FlexiKey and Double Take
 (6) Keyers per ME, (2) iDPMs, (2) Chroma Keyers, ImageStore Lance Controller

Records

(2) EVS XT3 8-Channel
 (1) EVS XT3 6-Channel LSM, 2-Channel Spotbox
 (1) EVS XFile 3
 Abekas Tria 3 Channel Clip Server
 (1) AJA HELO H.264 Recorder
 (14) AJA KiPro Ultra Recorders

Camera Equipment

Wired for up to 20 CCUs
 (12) Sony HDC-4300 Hybrid Fiber
 2160p/1080p/1080i/720p 59.94, 29.97, 23.98
 TAC Fiber Adapters Available
 (8) HH Viewfinders
 (8) 7" Studio LCD Viewfinders
 (4) Fujinon 20x ENG Lenses
 (6) Fujinon 13x4.5 Wide Angle Lenses
 Additional Camera/Lens Options Available
 3x SuperMotion Available

Communications

RTS ADAM 160 Port Digital Matrix
 (12) RTS PL Channels
 (6) RTS Telephone Interface
 (4) Wet IFB Channels
 (2) Biscuit Boxes

Connectivity

(2) VoIP Phone Lines
 Verizon 5G Internet Capable

Terminal Equipment

168x224 Imagine Communications 3G/HD Router
 (16) Configurable Integrated Multiviewer Outputs
 (12) Quad Split Multiviewers
 (12) Riedel Framesyncs/Embed/Deembed
 (1) For-A 5 Channel Color Corrector/UDC
 (4) AJA FS-4s UDC
 (4) Cobalt UDCs
 TSL Tallyman Tally Interface

Graphics Facilities

Wired for up to 2 Dual Channel CG Systems
 (1) Ross XPression 4k Dual Channel - SW ver 10.5

Cable Inventory

4000' Hybrid Fiber Optic Camera Cable
 2500' DT-12 Cable
 (2) 1000' TAC-12 Fiber Mult
 (2) 500' TAC-12 Fiber Mult

Audio Facilities

Studier Vista X Digital Mixing Console
 52 Fader / 344 DSP Inputs
 Full 5.1 Surround Sound Capable Mixing
 32x32 Analog, 36x36 AES, 256x256 MADI, 64x64 Dante
 Wired for up to 4 64x32 Fiber Stageboxes
 (2) 64x32 Fiber Stageboxes
 (1) Soundboard Audio Clip Server
 (1) Avid Pro Tools 128 Channel Audio Recording Rig
 (2) Sound Devices Pix 270i 64 Channel Audio Recorders
 (1) Waves SuperRack 64-Channel with Creative Access

Support

(2) Fostex Speakers
 (3) Throwdown HD Monitors
 (4) SDI-HDMI Converters
 (4) Fiber Rattler Sets
 (2) Decimator MD-Cross Converters

Power Requirements

3 Phase, 200 Amps, 208 Volts
 3 Hot Legs, 1 Ground, (No neutral required)
 200' feeder cable with camlock connectors

Truck Dimensions

GVW - 80,000 Lbs
 Dimensions - 61.5ft L, 17.5ft W, 13.5ft H working footprint

Resolutions & Frame Rates

2160p, 1080p, 1080i, 720p
 59.94, 29.97, 23.98

For mobile unit inquiries, call or text at 877-959-8638 or e-mail contact@tndv.com

Mobile unit equipment complement is subject to change without notice. Additional equipment is available as needed.

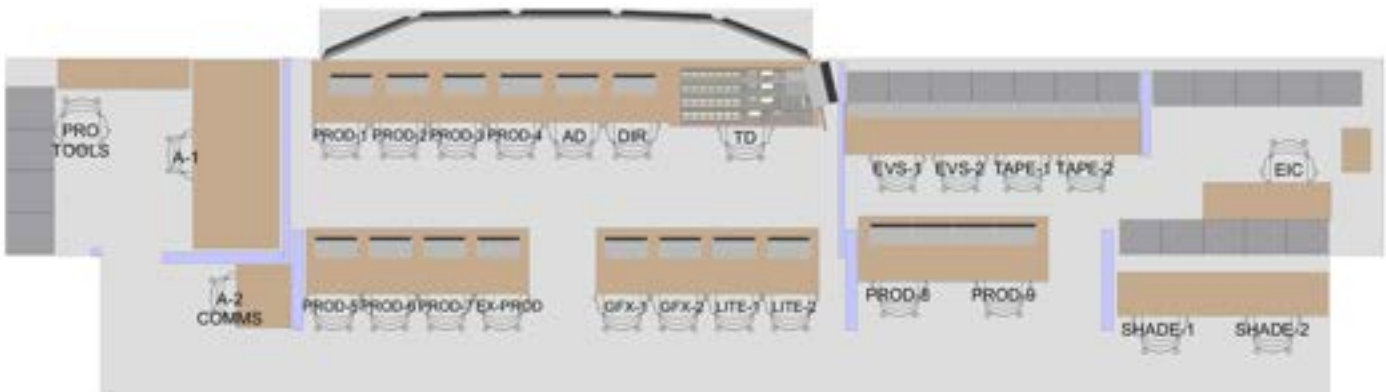

TNDV is a division of the Live Media Group Holdings family of companies

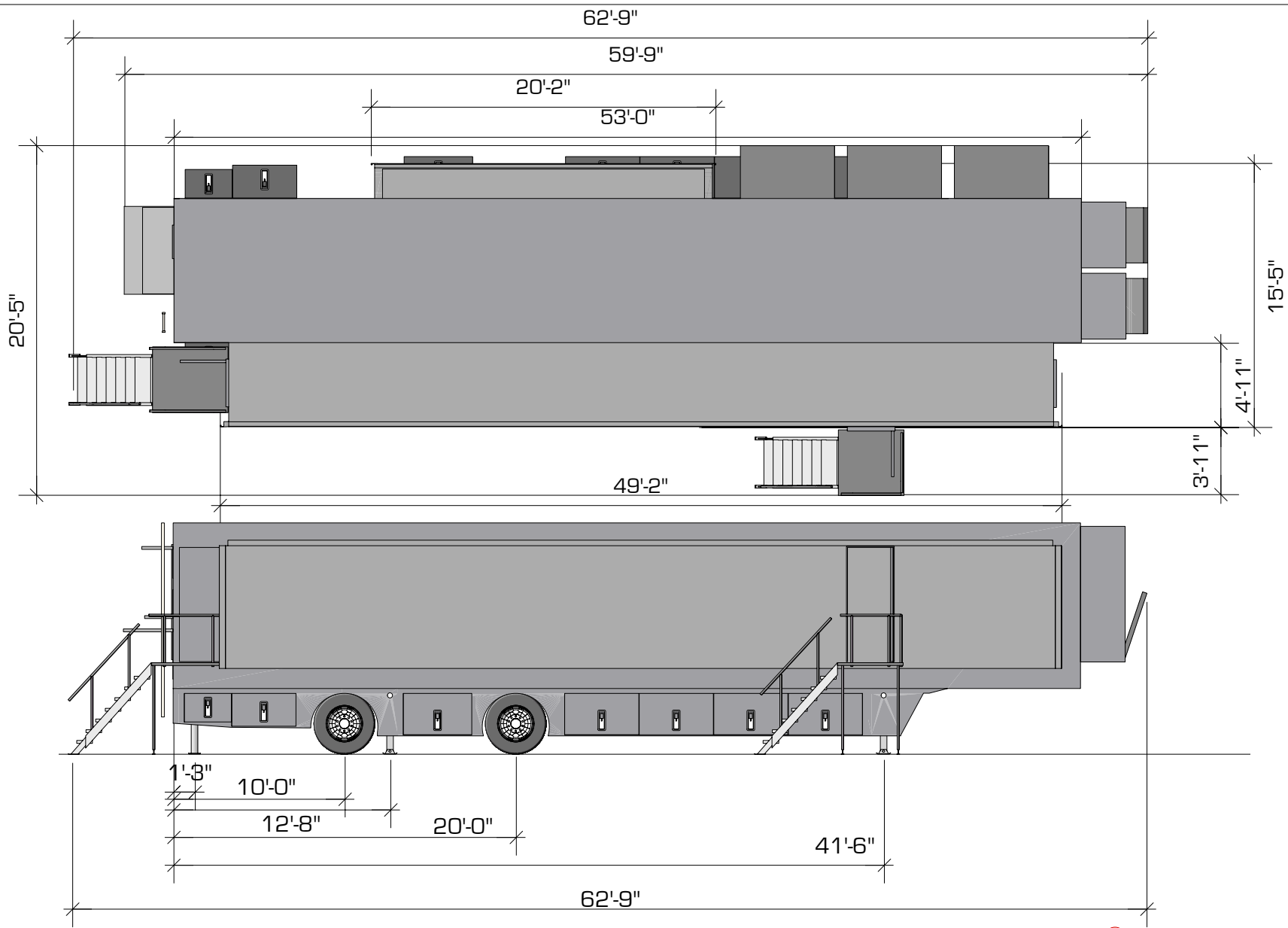

TNDV
TELEVISION
contact@tndv.com
877-959-TNDV
515 Brick Church Park Drive
Nashville TN 37207

**53' DOUBLE
EXPANDO**

TNDV EXCLAMATION

FILE: TNDV_EXCLAMATION_3D_2024.kwd
PRODUCTION DRAWINGS BY: Joseph Fetzer

SHEET INFO:
DIMENSION SET
TOP AND SIDE

NOTES:

UPDATED:
Date: 9/5/24
Time: 3:17:12 PM
Ver.005



53' DOUBLE
EXPANDO

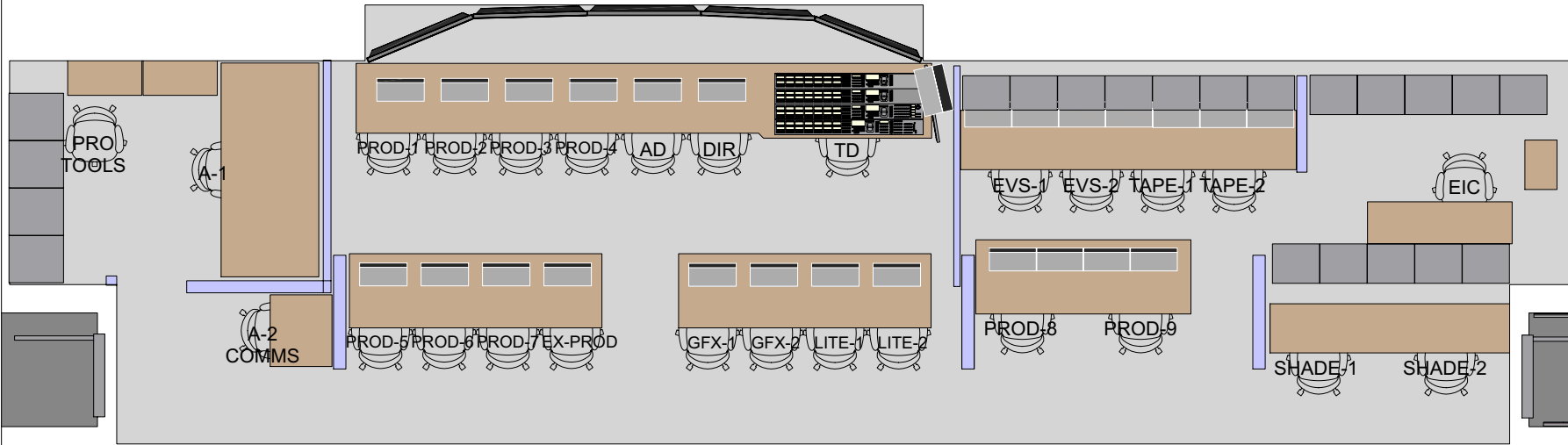

#	LOCATION	NAME:
1	PROTOOLS	
2	A-1	
3	A-2 COMS	
4	PROD 1	
5	PROD 2	
6	PROD 3	
7	PROD 4	
8	AD	
9	DIRECTOR	
10	TD	
11	PROD 5	
12	PROD 6	
13	PROD 7	
14	EXSECUTIVE PROD	

#	LOCATION	NAME:
15	GFX 1	
16	GFX 2	
17	LIGHTING 1	
18	LIGHTING 2	
19	PROD 8	
20	PROD 9	
21	EVS 1	
22	EVS 2	
23	TAPE 1	
24	TAPE 2	
25	SHADER 1	
26	SHADER 2	
27	TRUCK EIC	
28		

TNDV EXCLAMATION

FILE: TNDV_EXCLAMATION_3D_2024.kwk
PRODUCTION DRAWINGS BY: Joseph Fetzer

SHEET INFO:
EXCLAMATION
FLOOR PLAN
SEATING
ASSIGNMENTS

NOTES:

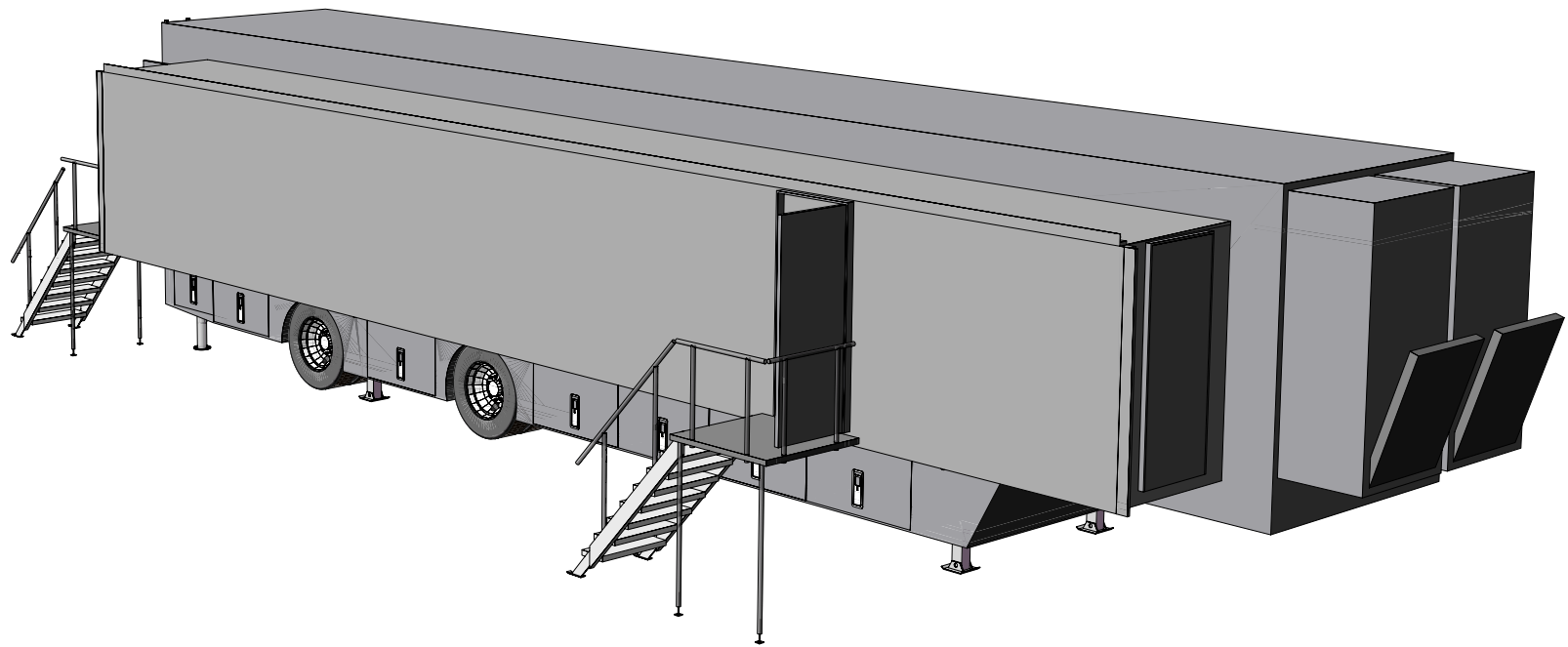

TNDV
TELEVISION



TNDV
TELEVISION
contact@tndv.com
877-959-TNDV

515 Brick Church Park Drive
Nashville TN 37207

**53' DOUBLE
EXPANDO**

TNDV EXCLAMATION

FILE: TNDV_EXCLAMATION_3D_2024.kwk

PRODUCTION DRAWINGS BY: Joseph Fetzer

SHEET INFO:

EXCLAMATION
ISOMETRIC VIEW

NOTES:

UPDATED:

Date: 9/5/24
Time: 3:17:24 PM

Ver.005

4 TNDV EXCLAMATION 3D 2024
Scale: 1:17

"EXCLAMATION"

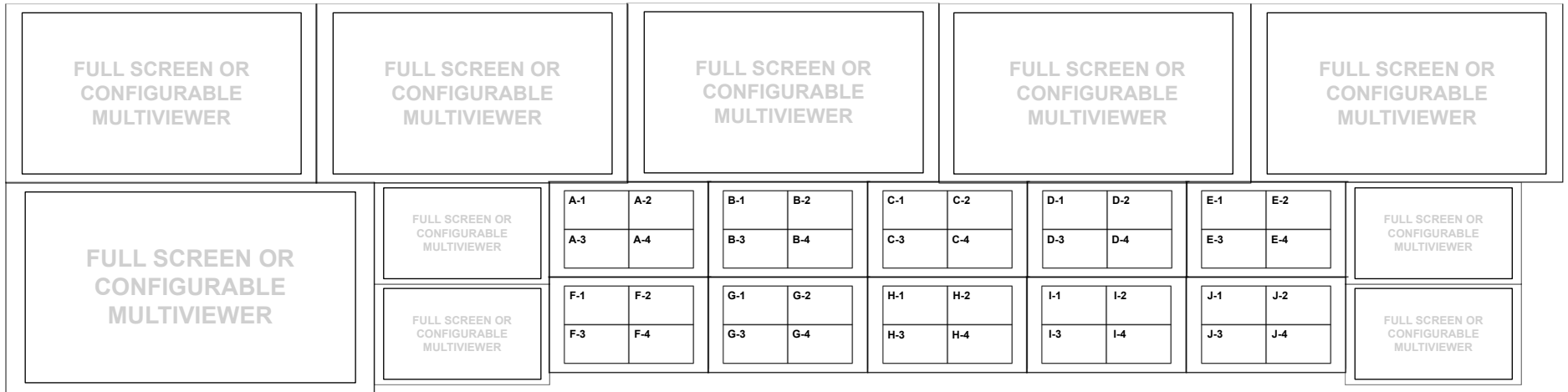

Open Position

Open Position

Open Position

Assistant Director

Director

Technical Director



53' DOUBLE
EXPANDO

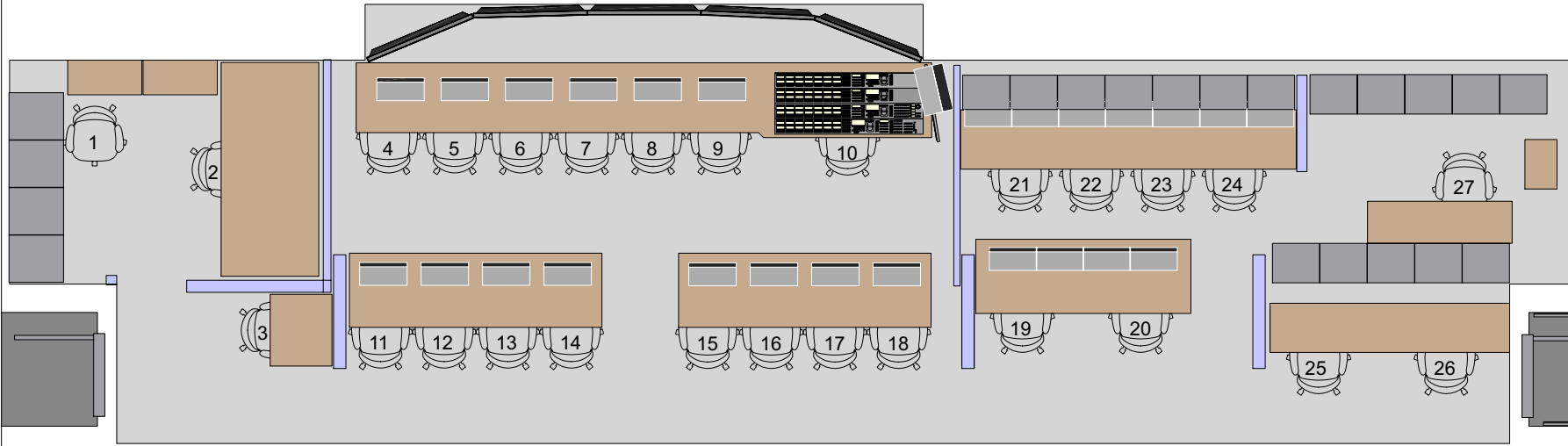

PRODUCTION SEATING ASSIGNMENTS

1	
2	
3	
4	
5	
6	
7	
8	
9	
10	
11	
12	
13	
14	

15	
16	
17	
18	
19	
20	
21	
22	
23	
24	
25	
26	
27	
28	

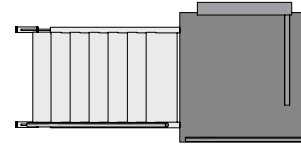

TNDV EXCLAMATION

FILE: TNDV_EXCLAMATION_3D_2024.kwd
PRODUCTION DRAWINGS BY: Joseph Fetzer

SHEET INFO:
BLANK
FLOOR PLAN

NOTES:

2 TNDV EXCLAMATION 3D 2024
Scale: 1:20.2

UPDATED:
Date: 9/5/24
Time: 3:17:22 PM
Ver.005