

INSPIRATION

Scalable. Proven. Small footprint with big results

Production

Grass Valley K-Frame Switcher Frame
 Grass Valley Korona 3-Stripe 25-Button Control Panel
 2.5 M/Es available, 32 input, 16 output, FlexiKey and Double Take
 (6) Keyers per ME, (2) iDPMs, (2) Chroma Keyers, ImageStore Lance Controller

Records

(1) EVS XT2 6-Channel
 (1) EVS XFile 3
 (1) AJA HELO H.264 Recorder
 (12) AJA KiPro Rack Recorders

Camera Equipment

Wired for up to 10 CCUs
 (8) Hitachi SK-HD1200 Hybrid Fiber
 TAC Fiber Adapters Available
 (4) HH Viewfinders
 (4) 7" Studio LCD Viewfinders
 (2) Fujinon 20x ENG Lenses
 (4) Canon 11x4.7 Wide Angle Lenses
 Additional Camera/Lens Options Available

Communications

RTS ODIN 112 Port Digital Matrix
 (12) RTS PL Channels
 (4) RTS Telephone Interface
 (4) QKT Telephone Interface
 (8) Wet IFB Channels
 (2) Biscuit Boxes

Connectivity

(2) VoIP Phone Lines

Terminal Equipment

96x96 Imagine Communications 3G/HD Router
 4x4 Audio Embed/De-Embed
 (12) Configurable Integrated Multiviewer Outputs
 (4) Quad Split Multiviewers
 (12) 3G/HD Frame Syncs
 TSL Tallyman Tally Interface

Graphics Facilities

(1) Ross XPression Dual Channel - SW ver 10.5

Cable Inventory

3000' Hybrid Fiber Optic Camera Cable
 1200' DT-12 Cable
 (1) 1000' TAC-12 Fiber Mult
 (1) 500' TAC-12 Fiber Mult

Audio Facilities

Soundcraft Vi3000 Digital Mixing Console
 24 Fader / 96 DSP Inputs
 32x24 Analog, 128x128 MADI
 (1) 64x32 Fiber Stagebox
 (1) Avid Pro Tools 128 Channel Audio Recording Rig
 (1) Sound Devices Pix 270i 64 Channel Audio Recorder

Support

(2) Fostex Speakers
 (3) Throwdown HD Monitors
 (4) SDI-HDMI Converters
 (4) Fiber Rattler Sets
 (2) Decimator MD-Cross Converters

Power Requirements

1 Phase, 150 Amps, 208 Volts
 2 Hot Legs, 1 Ground, (No neutral required)
 150' feeder cable with camlock connectors

Truck Dimensions

GVW - 46,000 Lbs
 Dimensions - 45ft L, 14ft W, 13.5ft H working footprint

Resolutions & Frame Rates

1080p, 1080i, 720p
 59.94, 29.97, 23.98

For mobile unit inquiries, call or text at 877-959-8638 or e-mail contact@tndv.com

Mobile unit equipment complement is subject to change without notice. Additional equipment is available as needed.

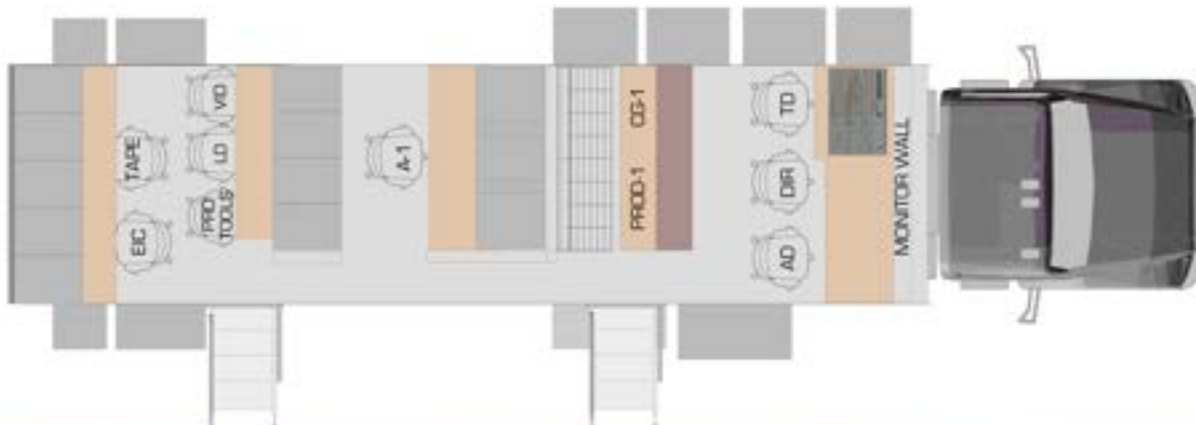

TNDV is a division of the Live Media Group Holdings family of companies

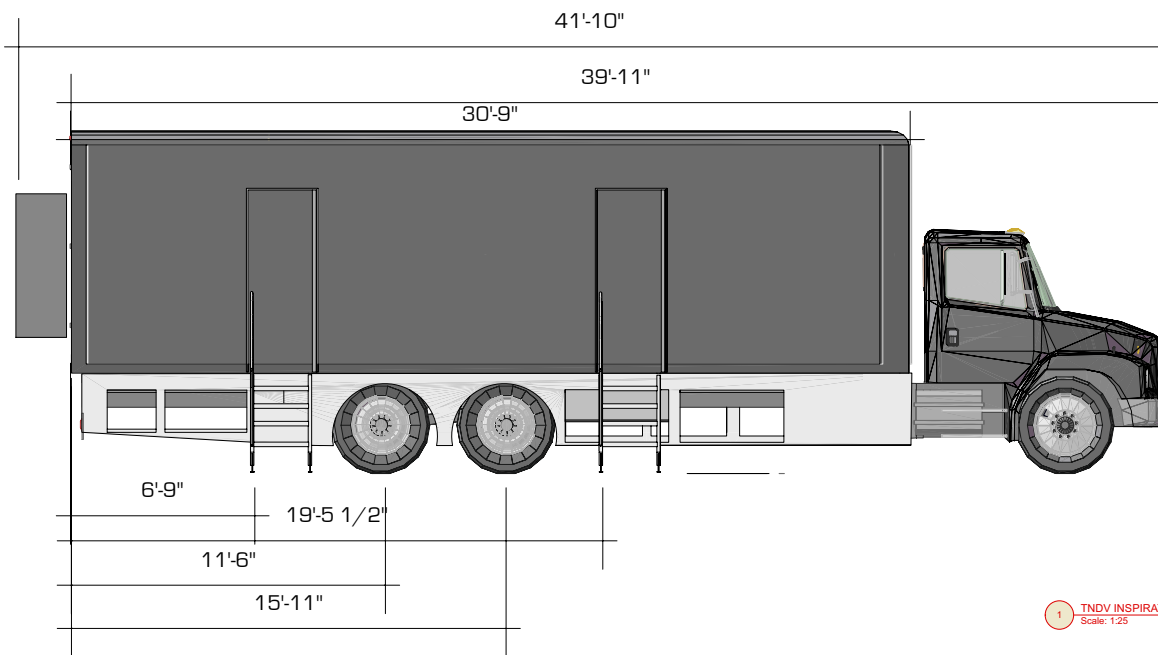
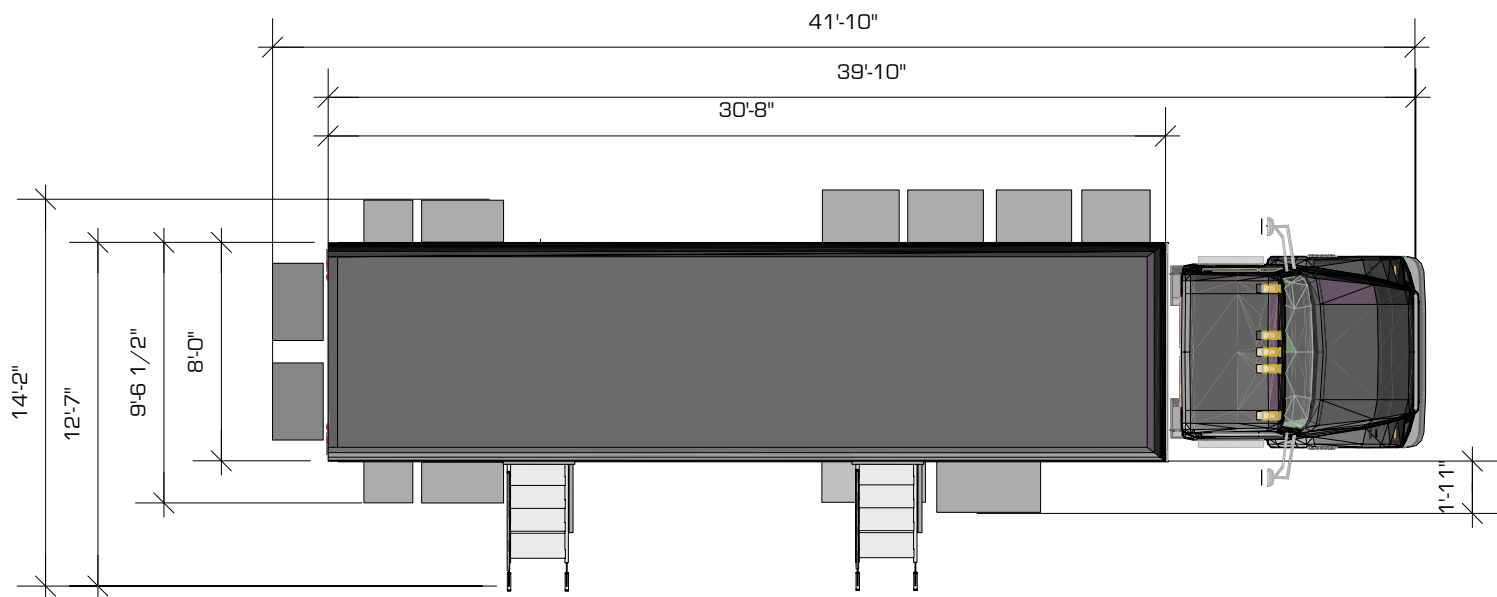

1 TNDV INSPIRATION.3D.2024
Scale: 1:25



TNDV
TELEVISION
contact@tndv.com
877-959-TNDV
515 Brick Church Park Drive
Nashville TN 37207

INSPIRATION
40' STRAIGHT
TRUCK

TNDV INSPIRATION

FILE: TNDV INSPIRATION.3D.2024.wrk
PRODUCTION DRAWINGS BY: Joseph Fetzer

SHEET INFO:
INSPIRATION
ISOMETRIC VIEW

NOTES:

UPDATED:
Date: 9/4/24
Time: 10:57:29 AM

Ver.005

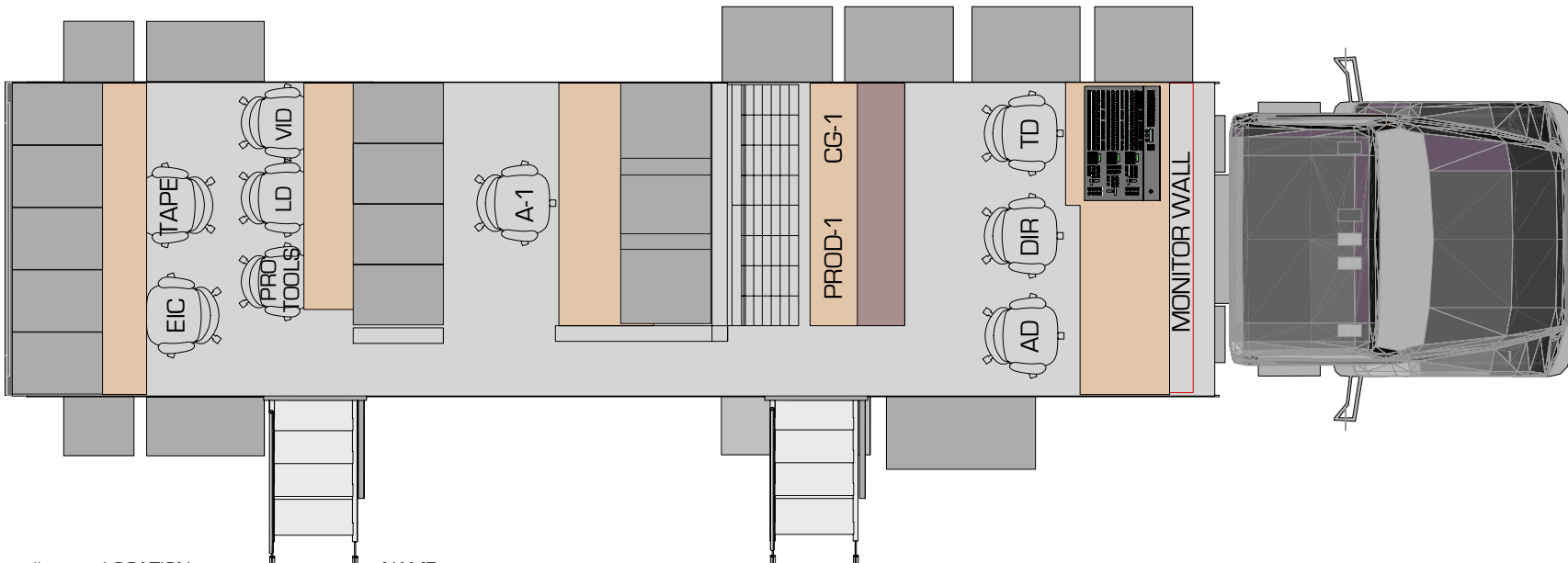

#	LOCATION	NAME:
1	TAPE	
2	EIC	
3	SHADER	
4	LIGHTING	
5	PROTOOLS	
6	A-1	
7	CG-1 BENCH 1	
8	PROD-1 BENCH 2	
9	TD	
10	DIR	
11	AD	

2 TNDV INSPIRATION.3D.2024
Scale: 3/4" = 1'-0"

TNDV
TELEVISION



TNDV
TELEVISION
contact@tndv.com
877-959-TNDV

515 Brick Church Park Drive
Nashville TN 37207

**INSPIRATION
40' STRAIGHT
TRUCK**

TNDV INSPIRATION

FILE: TNDV INSPIRATION.3D.2024.wrk

PRODUCTION DRAWINGS BY: Joseph Fetzer

SHEET INFO:

INSPIRATION
FLOOR PLAN
SEATING
ASSIGNMENTS

NOTES:

UPDATED:

Date: 9/4/24
Time: 10:57:32 AM

Ver.005

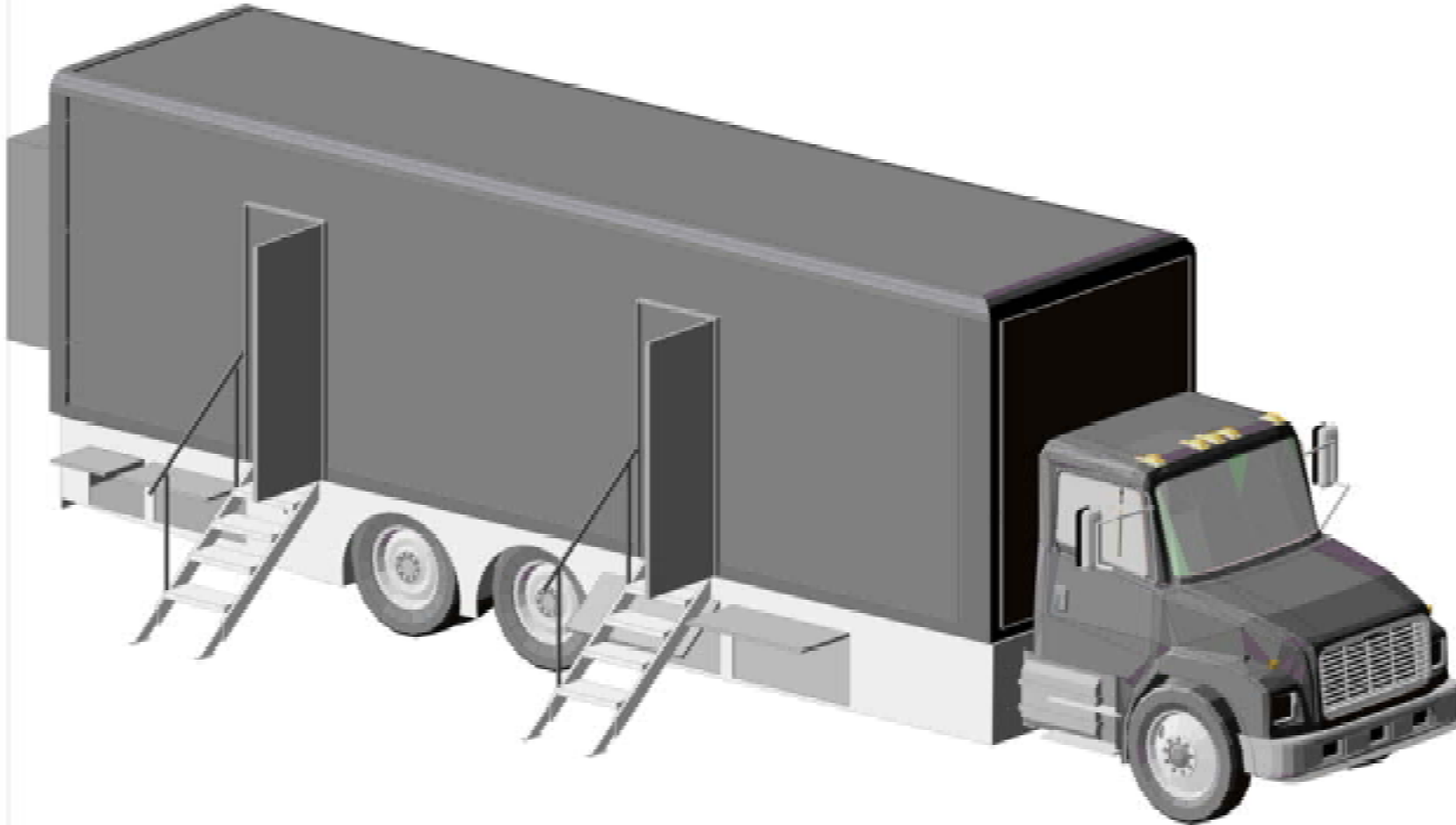

TNDV INSPIRATION.00.0004
Scale: 1:10

TNDV
TELEVISION

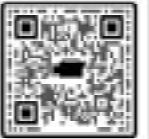

1100
TELEVISION
INSPIRATION
877.666.TNDV
410 West Orange Ave. One
Atlanta, GA 30307

**INSPIRATION
AD STRAIGHT
TRUCK**

TNDV INSPIRATION

FILE: TNDV INSPIRATION.00.0004.dwg
PUBLISHED/DRAWN BY: Joseph T. Foster

0407.000

INSPIRATION
TRUCK

NOTE:

UPDATES:

Date: 9/16/24
Time: 10:58:45 AM
Ver.005

“INSPIRATION”

FULL SCREEN OR CONFIGURABLE MULTVIEWER		FULL SCREEN OR CONFIGURABLE MULTVIEWER		FULL SCREEN OR CONFIGURABLE MULTVIEWER		FULL SCREEN OR CONFIGURABLE MULTVIEWER	
A-1	A-2	B-1	B-2	C-1	C-2	D-1	D-2
A-3	A-4	B-3	B-4	C-3	C-4	D-3	D-4

Technical Director

Director

Producer

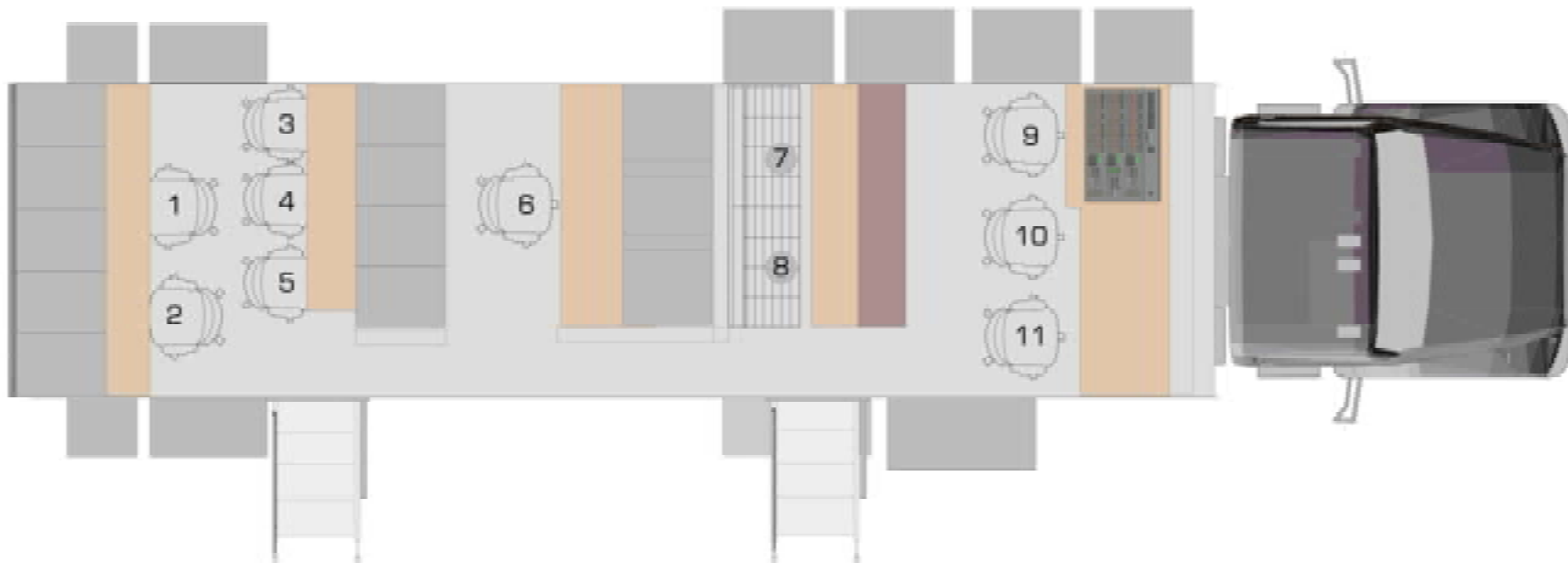

PRODUCTION SEATING ASSIGNMENTS

1	
2	
3	
4	
5	
6	
7	
8	
9	
10	
11	

TNDV INSPIRATION
Book 3'-4" x 11"

TNDV
TELEVISION

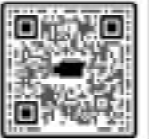

TNDV
TELEVISION
www.tndv.com
877.666.7634
410 Area Center Ave. One
Atlanta, GA 30327

**INSPIRATION
AD STRAIGHT
TRUCK**

TNDV INSPIRATION

FILE: TNDV INSPIRATION_3D_2024.dwg
PRODUCED/DRAWN BY: Joseph Troner

DATE: 06/05/24
VERSION: 04/05/24 PLAN

NOTE:

UPDATES:
Date: 6/5/24
Time: 10:58:54 AM
Ver.005